



0.8
mm

Optional 0.4 mm

Detector

1500
pcs. / min

Performance

100
Watt

X-ray source

X-RAY INSPECTION

RAYCON D+ MX LW

Intelligent curtainless X-ray inspection system
for light or sharp-edged packaged products

- Conformity & Accuracy
- Safety for people & product
- Simple operating concept
- Hygienic design concept
- Efficiency in all areas
- Reliable and fast service

YOUR PRIORITIES, OUR ANSWERS:

Optimum X-ray inspection with the 6P concept

Our X-ray systems have been specially developed for use in the food industry and reliably detect foreign bodies such as metals, glass, ceramics, stones, raw bones, PVC and many other product defects. Through this precise inspection, conformity with all important guidelines of the food industry such as IFS, BRC or FSSC 22000 are fulfilled and reliable protection against complaints and recalls can be ensured. The RAYCON D+ MX LW is curtainless and therefore especially suitable for light or sharp-edged products.

RAYCON exceeds international standards:



Curtainless machine

Due to the omission of curtains, the RAYCON D+ MX LW is perfect for inspecting light products.

Multi-lane

The RAYCON D+ MX allows simultaneous product inspection on up to 4 lines, i.e. products from several production lines can be combined on one device. However, the products to be inspected per lane must always be the same.

Detection of product defects

The RAYCON D+ MX LW reliably detects reliably product defects such as missing, broken or deformed products.

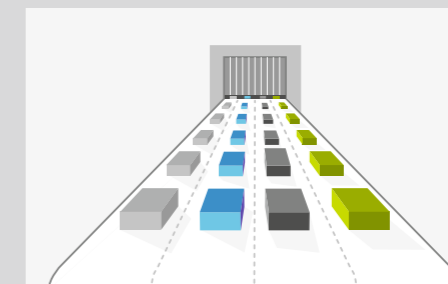
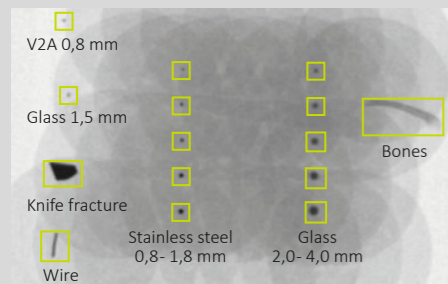

P1 Conformity & Accuracy

Reliable detection of metallic and non-metallic foreign objects throughout the inspection area enables compliance with all current specifications and standards.

- RAYCON D+ MX LW X-ray inspection equipment offers detection accuracy from 0.6 mm stainless steel, better than the 0.8 mm required by IFS
- In addition, no blind spot even with tall products (bottom-up X-ray inspection).
- Optimal traceability through complete logbook and optional image archiving (Insight.net or INTERLINK)
- UL/CSA certified

P2 Safety for people & product

Thanks to highly effective radiation protection and dosed use of X-rays, the RAYCON D+ MX LW enables all-round safe operation for people and products.

- X-ray radiation for operators is less than 0.1 µSv/h, which eliminates the need for documentation of operating times
- When a cover is opened, the X-ray radiation is switched off and the pneumatic system's air is de-energized
- The X-ray inspection equipment can be used without any concerns even for organic products
- RFID login: maximum access protection

P3 Simple operating concept

Thanks to a large touchscreen, easy-to-understand user guidance and features such as the Auto-Learn function, the RAYCON D+ MX LW offers particularly easy handling in everyday use.

- An auto-learn function makes operation very simple and intuitive. Specific knowledge of image processing or x-ray operation is not required
- Multi-product software enables automatic inspection of different products on one line
- RFID login for increased ease of use

P4 Hygienic design concept

Open modular design provides for easy access to the conveying area in the product zone without tool for simplified cleaning and maintenance.

- No radiation curtains required – eliminates risk for re-contamination after cleaning and reduces operating costs
- Complete construction in stainless steel and plastics with suitability for the food industry (according to EC1935/2004)
- The materials are designed in such a way that they can be cleaned repeatedly and intensively without abrasion. Water runs off automatically due to beveled surfaces.
- Conveying area: Protection class IP66

P5 Efficiency in all areas

Thanks to high speeds and multi-lane capability, up to 1500 products per minute can be inspected in real time – on a maximum of four parallel lines.

- Durable and sophisticated core components with 100 W X-ray source and 0.8 mm detector
- Detection of the lifetime of the X-ray source (early warning system for plannable source replacement)
- Suitable for high belt speeds up to 1.4 m/sec
- Reliable Detection of other product defects such as missing, broken or deformed products

P6 Reliable and fast service

With warranty services, a combined on-site and remote service and targeted training, you have optimal support for smooth operation.

- Spare parts packages including wear parts ensure maximum up-time
- Remote service via Teamviewer / Pilot App
- Customer-specific training for operation, radiation protection and service/maintenance
- High overall system efficiency and stable operation
- Lifetime warranty with the Sesotec Lifetime Warranty package

Functional diagram

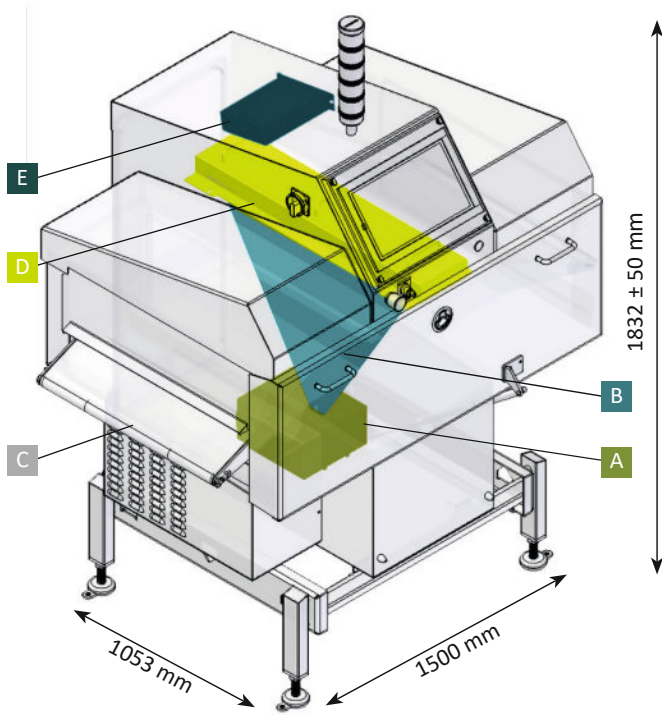

The system consists of the following main components:

- A** X-ray tube: Here the X-rays are generated electrically. They exit the tube through a narrow slit and penetrate the products to be inspected/examined from the bottom to the top as a fan-shaped beam.
- B** X-ray beam
- C** Transport system: A PE flat belt (self-guiding) transports the product to be examined evenly through the X-ray beam. This makes it possible to scan the product line by line.
- D** Detector unit: The linear detector installed above the inspection aperture converts the incoming X-ray beams into an electrical signal from which a digital X-ray image is generated.
- E** Industrial PC: This is where image evaluation and precise control of the reject systems take place.

Detection performance

The detectability of foreign bodies in X-ray systems with single-energy technology depends primarily on the density of the foreign body. All foreign bodies with a density significantly higher than the product density are very well detectable. These include, for example, metals, glass, stones, ceramics in products such as sausage, cheese, meat, etc. However, thanks to the high-resolution detector and the sophisticated software evaluation using a large number of filters in the RAYCON D+ MX LW, bones, rubber, Teflon, PVC, etc. can also be reliably detected. A free test with your product provides you with a meaningful basis for decision-making.

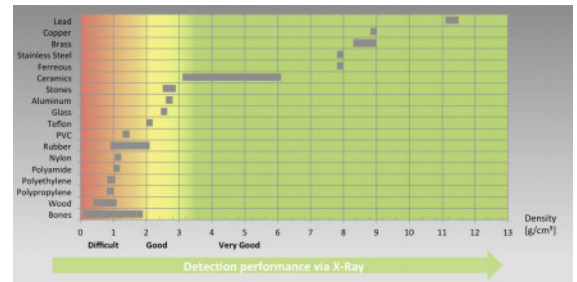

The RAYCON Family

RAYCON D+ MX LW

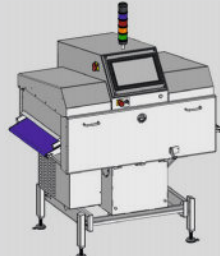
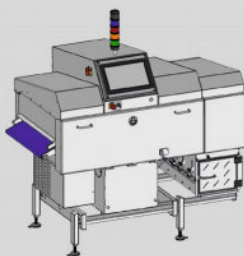

RAYCON D+ HX LW

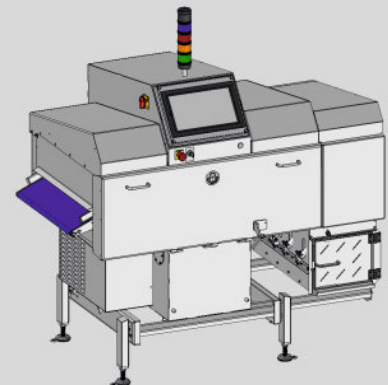

The curtainless top device of the RAYCON family with highest detection precision from 0.3 mm for light or sharp-edged packaging with a product height below 50 mm.

Belt width: 360 mm	Belt width: 660 mm
X-ray source: 40 - 50 KV / 2.0 - 2.5 mA (100W)	X-ray source: 40 - 50 KV / 2.0 - 2.5 mA (100W)
Detector: 0.8 mm (0.4 mm optional)	Detector: 0.8 mm (0.4 mm optional)
Max. Inspection area (W x H): 330 x 50 mm	Max. Inspection area (W x H): 630 x 50 mm
Variations: signal only, separated or integrated reject system with 1 or 2 flaps	Variations: signal only, separated or integrated reject system with 1 or 2 flaps